



astep®

COLLECTION



Timeless Inventions — *Astep creates and curates meaningful design objects. Honoring the vivid tradition of Italian design, we focus on creating the New, while continuing the life of timeless works that were born from the same forward-thinking attitude and maintain a capacity to affect and enlighten our lives today.*

To be innovative, one must understand and respect tradition. We combine the experience, knowledge and future-oriented outlook, that has been nurtured in the Sarfatti family for three generations, with the newest technology and likeminded, visionary designers of the present.

Candela

The Evolution of Light

Design by Francisco Gomez Paz, 2016

Continuing the long tradition of Scandinavian flame luminaires, Candela – which is Italian for candle – brings this classic product typology into the 21st century with the newest technology, turning the heat of a flame into electricity. It was designed by Argentinian designer Francisco Gomez Paz in a visionary collaboration with Astep. A shared passion for significant lighting solutions has led to a signature luminaire; a manifesto that addresses the evolution of design and technology. The evolution of light.

The use of fire to power LED lights simultaneously represents both the oldest and the newest form of illumination in a single product that is also environmentally friendly. Astep has developed a novel energy-harvesting system that generates electricity from the heat of the flame using the thermoelectric Seebeck effect, which was discovered by Thomas Johann Seebeck in the 19th century.

A portable and self-powered luminaire, Candela is ideal for cafés, restaurants and lounges as well as private homes as a source of warm light and a stylish power port. Due to the smokeless flame, Candela can be used both indoors and outdoors.

Candela is assembled in Italy of recyclable materials such as opalescent glass and aluminum and a variety of advanced high-temperature thermal materials and powered by bioethanol, a clean, natural and renewable fuel made from plants.

Recharge – Candela is a sustainable lighting solution and design statement that enables you to recharge your devices via a USB cable. With an internal battery that charges whenever there is a flame, Candela can charge mobile phones and tablets even when powered off. The luminaire is easily ignited with a match or lighter. A full tank contains 260 ml of bioethanol – enough for five hours of use.



Candela

Design by Francisco Gomez Paz, 2016



The Seebeck effect is a phenomenon discovered in the 19th century in which the temperature difference between two different electrical conductors produces a voltage difference between the two electrodes. When heat is applied to one of the two conductors, heated electrons flow toward the cooler one. If the pair is connected in an electrical circuit, direct current flows through the circuit.

Regardless of the scientific significance of this discovery, the voltages produced by the Seebeck effect are small, usually only a few microvolts per kelvin of temperature difference. If the temperature difference is big enough, some Seebeck-effect devices can produce a few millivolts. However, by combining many Seebeck-effect devices it is possible to increase the output voltage and generate a useful, albeit small amount of electricity.

Using the thermoelectric Seebeck effect, Astep has developed a novel energy-harvesting system that generates electricity from the heat of a flame. In Candela, four heat collectors working together with a large aluminum heat sink provide the necessary temperature difference to create electrical power. This generates sufficient power to provide ambient LED illumination while storing excess energy that can be used to charge a mobile phone or tablet device later, making Candela a portable and self-powered luminaire.

The Seebeck effect is named after Thomas Johann Seebeck, who discovered the phenomenon in 1821.

The Seebeck effect

A Scientific Phenomenon

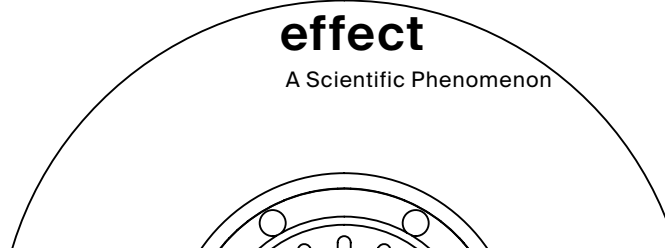
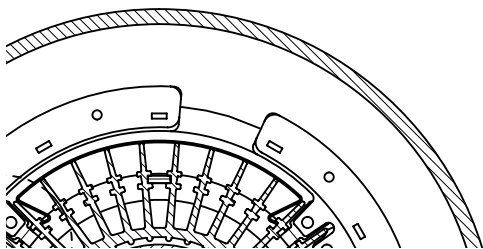



Nox

Nocturnal Spirit

Design by Alfredo Häberli, 2017

Nox embodies the playful and innovative energy of Alfredo Häberli in a softly beautiful portable luminaire. Named for 'night' in Latin, Nox in its very essence invites being moved around to embellish and brighten up everyday life, both indoors and outdoors.

Distinctive to Nox is its wireless charging system with induction technology, enabling this sophisticated and highly versatile lamp to be used unplugged. The luminaire is composed of four elements: a charging base, an anodized aluminium body containing the charging system, a hand-blown opaline glass diffuser and a simple handle.

Featuring a touch dimmer, Nox can provide ample light for reading and a cosy soft light when dimmed. Ideal as a bedside lamp, Nox can be picked up and carried to the balcony, and with its rich materials it also seems perfectly at home on the dinner table.

Nox is Alfredo Häberli's first lamp design for Astep. The internationally established designer is known for designs that combine tradition with innovation, thus exploring a creative landscape of crafts, interaction and evolution that is equally essential to Astep.

Nox is assembled in Italy of high-quality materials such as opaline glass and aluminium and provides up to fifteen hours of use when fully charged, leaving plenty of time to explore the night.



Distinctive to Nox is its wireless charging system with induction technology, enabling this sophisticated and highly versatile lamp to be used unplugged.

Nox

Design by Alfredo Häberli, 2017

Nox can be picked up and carried to the garden, with its rich materials, also feeling perfectly at home on the dinner table.



ASTEP

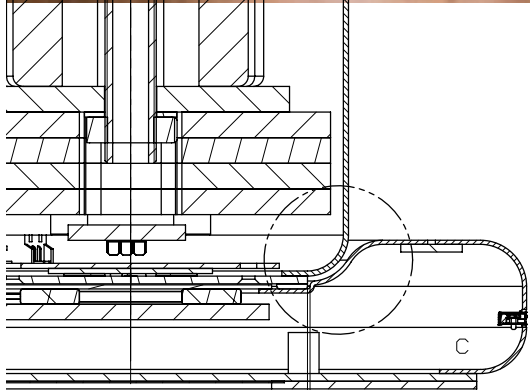

COLLECTION

NOX

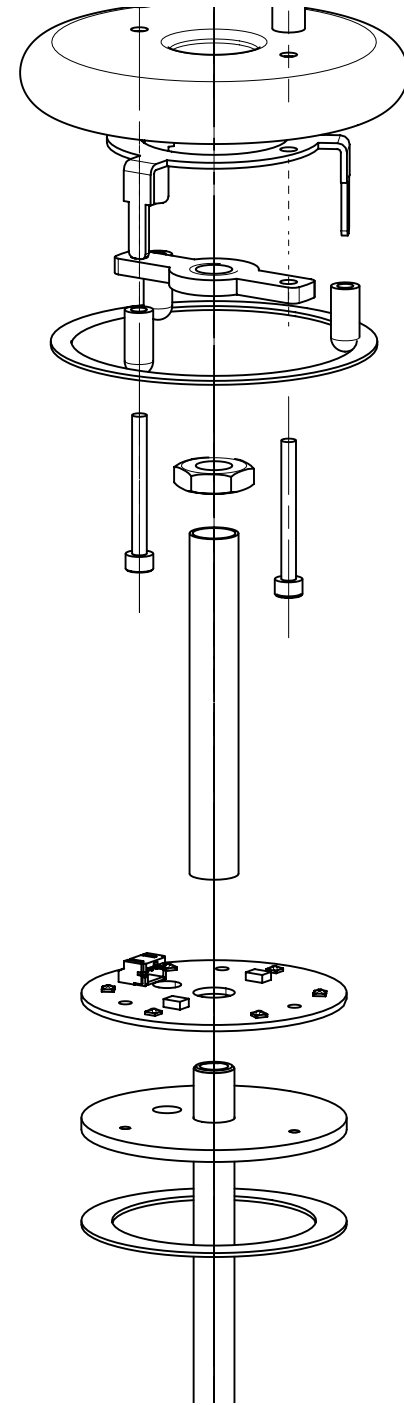

21

VV Cinquanta Collection

Versatile Italian Elegance

Design by Vittoriano Viganò, 1951/2016

VV Cinquanta is a versatile, timeless lighting collection by Italian architect Vittoriano Viganò with a compelling contemporary appeal. Created from an innovative, mid-century Italian design spirit and embracing the values that are at the very heart of Astep: a progressive attitude, objects invented from a wish to make an impact and design that strives to enhance our daily lives.

The original colours are as vivid as when Viganò decided on the colour scheme in 1951 during his time as art director for Arteluce. They set the tone of a versatile lighting universe that can be quiet or more dynamic. From white and black to red, yellow and blue, and from direct working light to upward lighting thanks to the master feature: the adjustable direct light source that can swivel and tilt.

Starring a sophisticated, wide reflector, VV Cinquanta comes in four models, which translate the basic design idea into four unique expressions. With respect for the origin of the design, Astep's roots and the proud artisanal and industrial traditions, the VV Cinquanta collection is made in Italy.



*The floor model stands gracefully
on a slender black iron base.*

VV Cinquanta Floor

Design by Vittoriano Viganò, 1951/2016

The wide reflector is mounted on an articulated stem that enables various lighting scenarios.



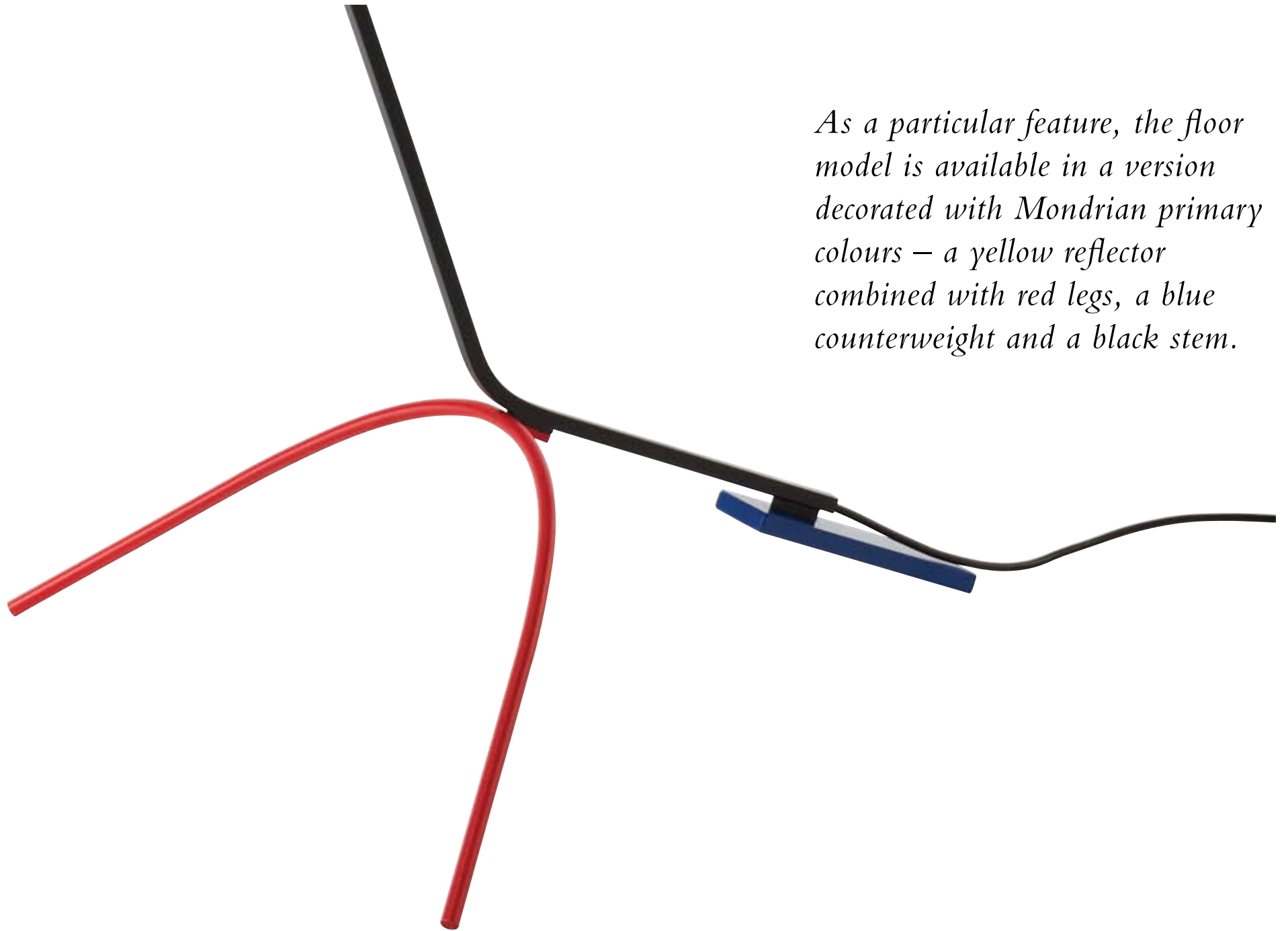

As a particular feature, the floor model is available in a version decorated with Mondrian primary colours – a yellow reflector combined with red legs, a blue counterweight and a black stem.



The wide signature reflector is combined with a narrow, almost understated reflector in a bold and intriguing companionship that makes the lamp stand out.

VV Cinquanta Suspension

Design by Vittoriano Viganò, 1951/2016

The suspension model is a sophisticated luminaire with a distinctive dual-operated design that encourages several dynamic lighting positions.

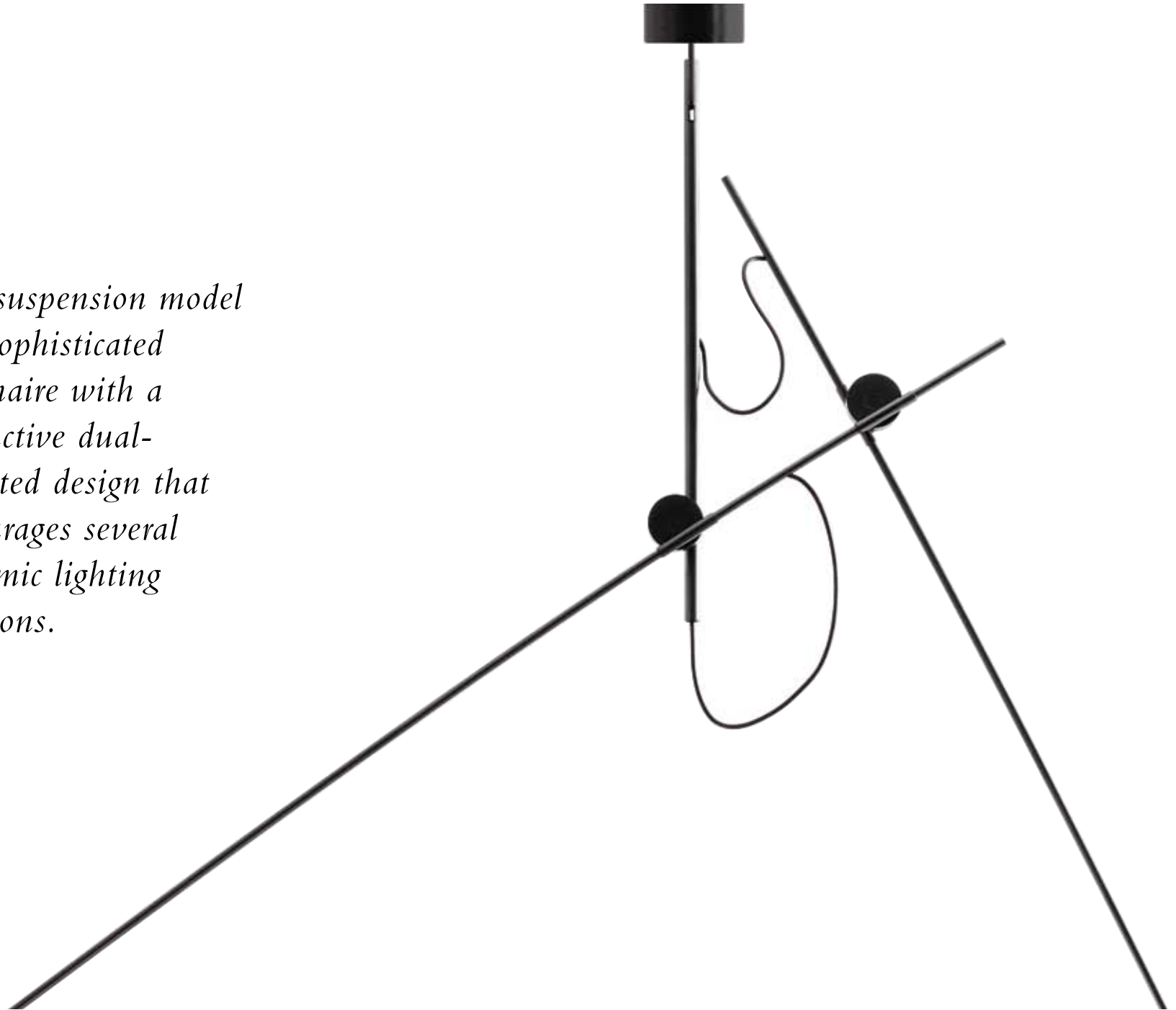



The twin model is an elegant two-armed wall light. Mounted on a brass bracket, the two brass arms reach out in opposite directions.

VV Cinquanta Twin

Design by Vittoriano Viganò, 1951/2016

The wide signature reflectors can be angled and rotated to provide both indirect and direct lighting simultaneously. A sculptural wall lamp with multiple lighting compositions.





The wall model is stylishly mounted on a bracket of brass or black aluminium for a simple, yet elegant expression.

VV Cinquanta Wall

Design by Vittoriano Viganò, 1951/2016



*The reflector itself
can be angled 160
degrees and rotated
350 degrees, making
the wall model an
outstandingly flexible
design for versatile use.*



Astep strives to explore new possibilities to advance the relationship between people and their homes, respecting the meaning of evolution in design.



Portrait by Hasse Nielsen

Alessandro Sarfatti

A family affair

‘We must work in all directions and in each one find a small amount of innovation.’ My father used to say this, and his approach has proven to be true. As long as we continue moving towards something that is more meaningful, more substantial, more relevant, every move is valuable and deserves the same consideration and respect.

That is the very core of Astep. To me, the essence of evolution is to capture the best of what has been and let it evolve into the heart of what is to come. Thus, Astep continues on the path devised by two great entrepreneurs, my father, Riccardo Sarfatti, and my grandfather Gino Sarfatti.

A family affair – Like all good Italian tales, mine is also a family affair and began a long time ago. In 1939, my grandfather Gino Sarfatti founded Arteluce, a company that pioneered the use of design in the lighting business.

In 1978, my father Riccardo went a step further. When founding Luceplan together with my mother, Sandra Severi, and architect Paolo Rizzatto, he moved from an artisanal to a more industrial approach and devised a new business model that became synonymous with ‘Made in Italy’ quality and innovation: working with highly specialized, talented and hand-picked industrial craftsmen.

Both Arteluce and Luceplan created one icon after another, luminaires of timeless beauty that embody the meaning of evolution. At Astep, we present a careful selection of works created by the great minds of the past in combination with new inventions by the great minds of the present. A collection of objects, fluid in time, that carry on the heritage and legacy of my family.

— Alessandro Sarfatti,
founder of Astep

Designers



Portrait by FGP

Francisco Gomez Paz

Designer (born 1975)

Since 2004, Francisco Gomez Paz has had his own design studio in Milan. He was born in Argentina but moved to Italy after completing his studies in Industrial Design in Córdoba and is driven by a profound curiosity and understanding of sophisticated technologies and materials. He creates and designs in a particularly experimental hands-on creative process, striving for innovation, significance and the mysterious quality of beauty.

Francisco Gomez Paz has created furniture and lighting products for a wide range of leading design companies, among them Luceplan, with whom he has developed highly innovative and iconic lighting solutions, including the Hope chandelier, which he designed in partnership with Paolo Rizzatto.

He is also active in the field of research and education, giving lectures in Italy and abroad, and in 2000 he was appointed visiting professor at Domus Academy, a living laboratory for design, architecture and fashion in Milan. He also holds a master's degree in Design from the Domus Academy.

Francisco Gomez Paz has received several international accolades for his work, among them the Good Design Award (2010), the prestigious Compasso d'Oro (2011) and the Red Dot Award (2010 and 2016). His Solar Bottle, designed together with Alberto Meda, was awarded first prize in the Index Award (2007) and was also selected for MOMA's Study Collection.



Portrait by Till Jenninger

Alfredo Häberli

Designer (born 1964)

For many years, Zurich has been home to Alfredo Häberli and his playful design developments. Before resettling in Switzerland with his family in 1977, Alfredo grew up in Argentina, and his work is strongly influenced by his childhood experiences and native country. He works with great emotion, energy and curiosity and benefits from having a visionary mindset, a serious attitude and a keen sense of details. The result is a collected work imbued with a strong expression and inherent emotionality and beauty.

Alfredo Häberli graduated, with distinction, as an industrial designer in 1991 and effortlessly combines tradition and innovation in every aspect of his work, from product designs for leading international design companies to architectural projects such as the Camper shops in Rome, Barcelona, San Sebastian, Zurich and Paris with their diverse, evocative looks.

His most extensive project so far is 25hours Hotel Zurich West (2012), where he was responsible for the interior decoration, choosing a design that mirrors the city with more than 60 bespoke items that create an artistic, allusive atmosphere. Among Alfredo Häberli's many talents are also exhibition design, curating and scenography.

Numerous awards and honours have been granted to Alfredo Häberli, including 'Guest of Honour' at the 20th Biennale of Design in Kortrijk (2006), 'Designer of the Year' by Architektur & Wohnen magazine (2009) and the 'Swiss Grand Prix of Design' from the Swiss Federal Office of Culture (2014).



Portrait from AVVM

Vittoriano Viganò

Architect and designer (1919-1996)

Italian architect and designer Vittorio Viganò was a multi-talent who has left a lasting impression across several fields and scales: from industrial design to architecture and from interior design to urban and landscape planning. He even excelled as a writer and art director.

Vittoriano Viganò graduated in Architecture from the Polytechnic School in Milan in 1944, and throughout his life he worked as Professor of Interior Architecture and Urban Planning parallel to his own architectural practice and other exploits. Architecture critics consider Vittorio Viganò the most important Italian exponent of the architectural 'Brutalism' movement that flourished around the world from the 1950s to the mid 1970s.

In the 1950s, Vittorio Viganò was art director of Arteluce, the lighting company founded by Gino Sarfatti, and designed numerous luminaires as well as the Arteluce flagship store on Via della Spiga in Milan. During these prolific years, he also designed several art galleries and took part in a number of Milan Triennale exhibitions. Owing to his eye for emerging architectural and cultural developments, Vittorio Viganò became the Italian correspondent for 'L'Architecture d'Aujourd'hui', the renowned French journal founded by artist André Bloc.

Vittoriano Viganò was awarded the architectural prize of the President of the Italian Republic (1990) by the San Luca Academy for his continued search for the rare balance between functionality, art and nature, and in 1994, his work was exhibited at the Milan Triennale in the comprehensive retrospective on the origins of Italian industrial design; two honours that emphasize the legacy of an extraordinary architect and designer.

Technical Sheets

CANDELA

Francisco Gomez Paz, 2016

Candela continues the long tradition of Scandinavian flame luminaries by advancing the product with 21st century technology. From the heat of the flame, Candela produces its own electricity to provide cosy LED illumination, while harvesting energy to charge mobile devices.

Candela is powered by bioethanol, a renewable fuel made from plants.

Technical specifications

Type	Portable Table Luminaire
Environment	Indoor
Materials	Opaline Glass, Aluminium, Alumina Wick, High-Temperature Materials
Finish	White Diffuser, Anodized Aluminium Fuel Tank
Dimensions	Ø 186 x 241 mm
Fuel Type	Bioethanol
Fuel Capacity	260 ml (5 Hours)
Light & Charge	12 LED, 2200 K Ca. 1,5 W Battery Capacity, 3400 mAh USB Type A Port
Light Only	24 LED, 2200 K Ca. 3 W

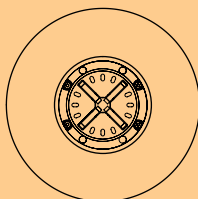
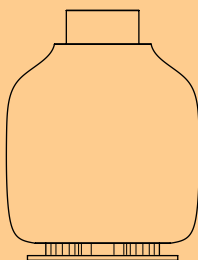

NOX

Alfredo Häberli, 2017

Nox is composed of four elements: a charging base, an anodized aluminium body containing the charging system, a hand-blown opaline glass diffuser and a simple handle. Distinctive to Nox is its wireless charging system with induction technology, enabling this sophisticated and highly versatile lamp to be used unplugged. Featuring a touch dimmer, Nox can provide ample light for reading and a cosy soft light when dimmed.

Nox is assembled in Italy of high-quality materials and provides more than fifteen hours of use when fully charged.

Technical specifications

Type	Portable Table Luminaire
Environment	Indoor
Materials	Opaline Glass, Aluminium
Finish	White Diffuser, Anodized Aluminium Body
Dimensions	Ø 224 x 305 mm (325 mm with charging base)
Connectivity	Micro USB Port
Light Source	8 LED, 2700 K 400 lm, CRI 85 Dimmer
Duration	15 Hours
Wireless Induction Charging Technology	

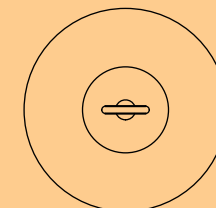
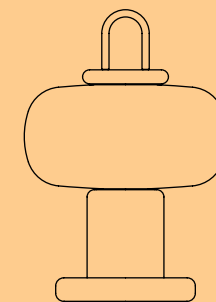

VV CINQUANTA – FLOOR

Vittoriano Viganò, 1951/2016

The floor model stands gracefully on a slender black iron base. The wide reflector is mounted on an articulated stem that enables various lighting scenarios. As a particular feature, the floor model is available in a version decorated with Mondrian primary colours.

Technical specifications

Type	Floor-standing Luminaire
Environment	Indoor
Materials	Spun Aluminium Reflector, Steel Frame
Finishes	<ul style="list-style-type: none"> • Black Frame with Colored Reflector: Black, White, Red, Yellow or Blue • Mondrian Primary Colors, Black Stem, Red and Blue Legs, Yellow Reflector
Dimensions	487 x 1472 x 1035 mm (WxHxD)
Light Source	1 x max 53 W - E27
Control	Switch on reflector

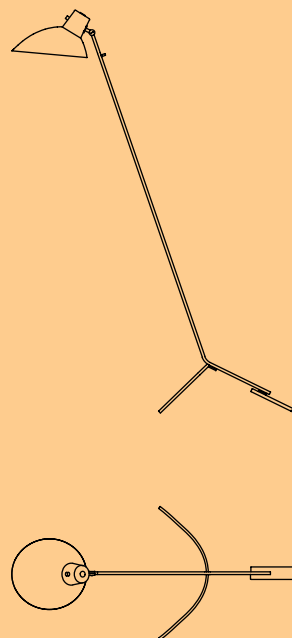

VV CINQUANTA – SUSPENSION

Vittoriano Viganò, 1951/2016

The suspension model is a sophisticated luminaire with a distinctive dual-operated design that encourages several dynamic lighting positions. The wide signature reflector is combined with a narrow, almost understated reflector in a bold and intriguing companionship that makes the lamp stand out.

Technical specifications

Type	Suspension Luminaire
Environment	Indoor
Materials	Spun Aluminium Reflectors, Steel Structure
Finishes	<ul style="list-style-type: none"> • Black Structure with Black and Black Reflectors • Black Structure with Black and White Reflectors • Black Structure with Black and Red Reflectors • Mondrian Primary Colors, Black and Red Structure, Blue and Yellow Reflector
Dimensions	1900 x 1800 x 255 mm (WxHxD)
Light Source	2 x max 53 W - E27

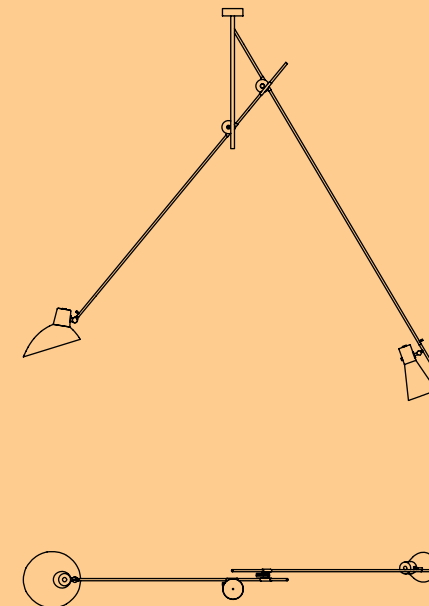

VV CINQUANTA – TWIN

Vittoriano Viganò, 1951/2016

The twin model is an elegant two-armed wall light. Mounted on a brass bracket, the two brass arms reach out in opposite directions. The two wide signature reflectors can be angled and rotated to provide both indirect and direct lighting simultaneously. A sculptural wall lamp with multiple lighting compositions.

Technical specifications

Type	Wall-mounted Luminaire
Environment	Indoor
Materials	Spun Aluminium Reflectors, Brass Structure
Finishes	<ul style="list-style-type: none"> • Brass Structure with Black Painted Reflectors • Brass Structure with White Painted Reflectors
Dimensions	1130 x 524 x 538 mm (WxHxD)
Light Source	2 x max 53 W - E27

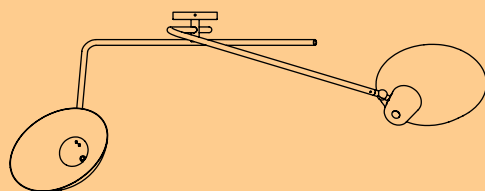
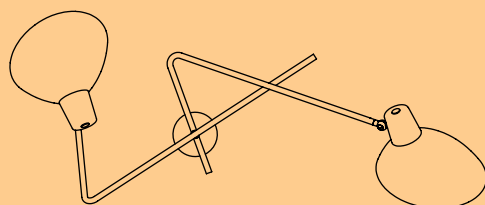

VV CINQUANTA – WALL

Vittoriano Viganò, 1951/2016

The wall model is stylishly mounted on a bracket of brass or black aluminium for a simple, yet elegant expression. The reflector itself can be angled 160 degrees and rotated 350 degrees, making the wall model an outstandingly flexible design for versatile use.

Technical specifications

Type	Wall-Mounted Luminaire
Environment	Indoor
Materials	Spun Aluminium Reflector, Brass Mount
Finishes	<ul style="list-style-type: none"> • Brass Mount with Painted Reflector: Black or White • Black Mount with Painted Reflector: Black, White, Red, Yellow or Blue
Dimensions	256 x 183 x 364 mm (WxHxD)
Light Source	1 x max 53 W - E27

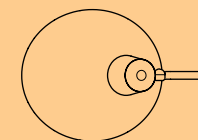

ASTEP

For sales inquiries please contact
sales@astep.design

Please note that Astep is also the sole worldwide
distributor of the Flos with Sarfatti Collection.
Please contact us for more information or visit our website.

Astep ApS

Vermundsgade 40B ST
2100 Copenhagen Ø Denmark

+45 70 70 50 01

www.astep.design

Astep reserves the right to introduce any
changes to its own models without prior notice



Copyright Astep 2017

PHOTOGRAPHY
Emanuele Tortora
Heidi Lerkenfeldt
Steffen Stamp

STYLING
BBDB – Barbara Busatta e Dario Buzzini
Pernille Vest

ART DIRECTION & GRAPHIC DESIGN
BBDB – Barbara Busatta e Dario Buzzini

PRINT
Tipografia Rumor, Vicenza – Italy

COLLECTION

*Timeless
Inventions*